

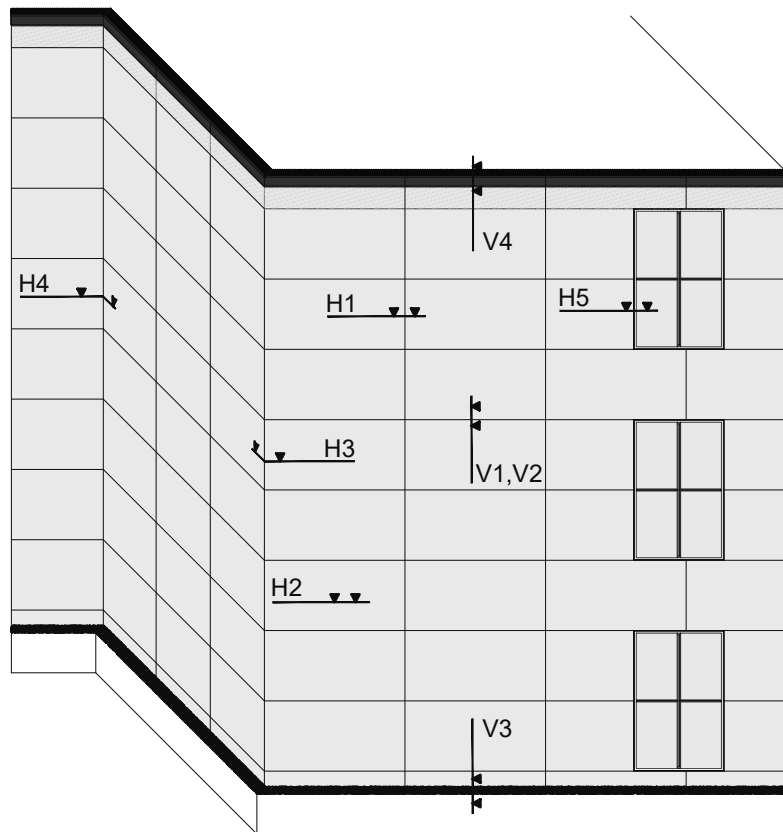

**ALLFACE**  
Smart Fixing Systems

# System F1.24



Construction depth	2
H1 – Horizontal section of Panel joint	3
H2 – Horizontal section of Mid support	4
H3 – Horizontal section of External corner	5
H4 – Horizontal section of Internal corner	6
H5 – Horizontal section of Window reveal	7
V1 – Vertical section of Fixed point	8
V2 – Vertical section of Sliding point	9
V3 – Vertical section of Bottom ending	10
V4 – Vertical section of Top ending	11

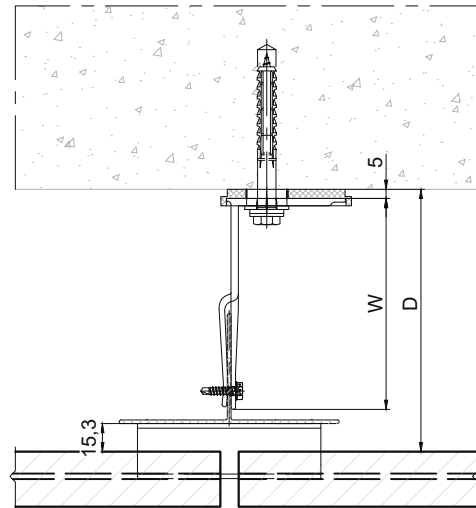

<b>BRACKET</b>	<b>DEPTH "W"</b>	<b>DISTANCE "D"</b>
F1.035 / F1+035	35 mm	67 - 95 mm
F1.050 / F1+050	50 mm	73 - 110 mm
F1.080 / F1+080	80 mm	103 - 140 mm
F1.100 / F1+100	100 mm	123 - 160 mm
F1.115 / F1+115	115 mm	138 - 175 mm
F1.135 / F1+135	135 mm	158 - 195 mm
F1.150 / F1+150	150 mm	173 - 210 mm
F1.170 / F1+170	170 mm	193 - 230 mm
F1.185 / F1+185	185 mm	208 - 245 mm
F1.200 / F1+200	200 mm	223 - 260 mm
F1.220 / F1+220	220 mm	243 - 280 mm
F1.255 / F1+255	255 mm	278 - 315 mm
F1.285 / F1+285	285 mm	308 - 345 mm
F1.320 / F1+320	320 mm	343 - 380 mm

