

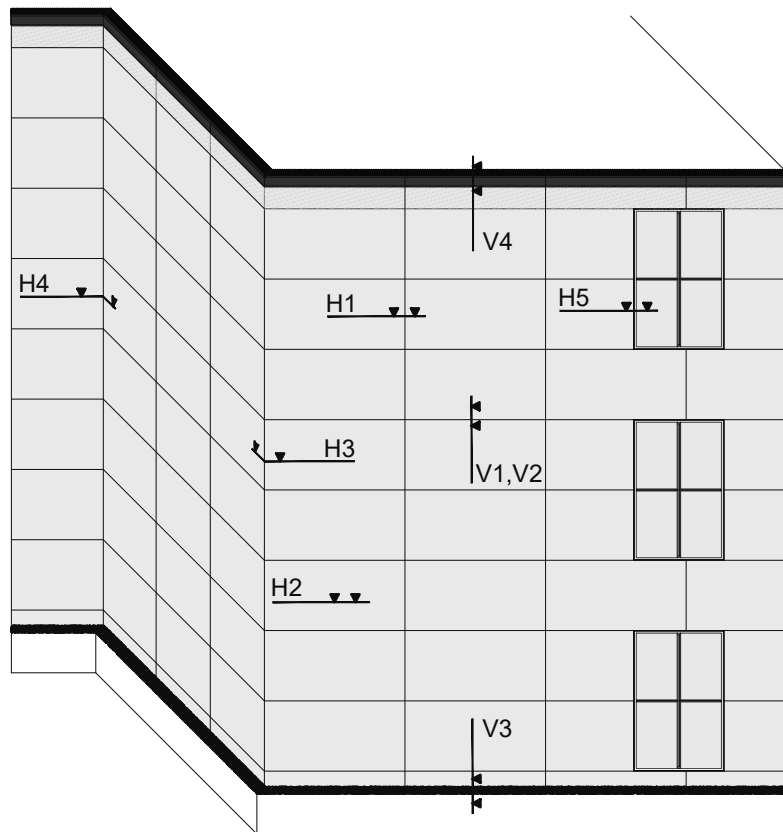

ALLFACE
Smart Fixing Systems

System F1.44



Construction depth	2
H1 – Horizontal section of Panel joint	3
H2 – Horizontal section of Mid support	4
H3 – Horizontal section of External corner	5
H4 – Horizontal section of Internal corner	6
H5 – Horizontal section of Window reveal	7
V1 – Vertical section of Fixed point	8
V2 – Vertical section of Sliding point	9
V3 – Vertical section of Bottom ending	10
V4 – Vertical section of Top ending	11

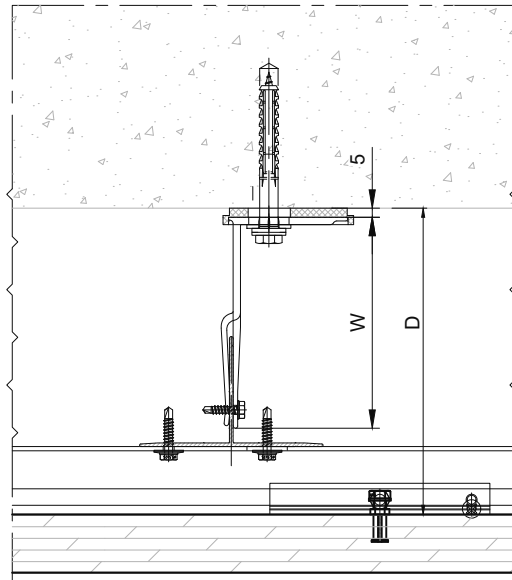

BRACKET	DEPTH "W"	DISTANCE "D"
F1.035 / F1+035	35 mm	88 - 117 mm
F1.050 / F1+050	50 mm	94 - 132 mm
F1.080 / F1+080	80 mm	124 - 162 mm
F1.100 / F1+100	100 mm	144 - 182 mm
F1.115 / F1+115	115 mm	159 - 197 mm
F1.135 / F1+135	135 mm	179 - 217 mm
F1.150 / F1+150	150 mm	194 - 232 mm
F1.170 / F1+170	170 mm	214 - 252 mm
F1.185 / F1+185	185 mm	229 - 267 mm
F1.200 / F1+200	200 mm	244 - 282 mm
F1.220 / F1+220	220 mm	264 - 302 mm
F1.255 / F1+255	255 mm	299 - 337 mm
F1.285 / F1+285	285 mm	329 - 367 mm
F1.320 / F1+320	320 mm	364 - 402 mm

